

Instruction Manual

Gas Refrigerator

Warning:

For your safety

Do not store or use gasoline or other flammable vapors and liquids in the vicinity of this or any other appliance.

If you smell gas:

1. Open windows.
2. Do not attempt to light appliance.
3. Do not touch electrical switches.
4. Extinguish any open flame.
5. Shut off fuel supply.
6. Evacuate immediately and call emergency services. Failures to follow these instructions could result in fire or explosion, which could cause property damage, personal injury, or death.

Warning:

Improper installation, adjustment, alteration, service or maintenance can cause injury or property damage. Refer to this manual. For assistance or additional information consult a qualified installer, service agency or the gas supplier.

Warning: suffocation and entrapment hazard

Prior to disposal of refrigerator:

1. Remove fresh food and freezer doors.
2. Leave shelves and baskets in place to prevent children from easily climbing inside refrigerator.

- Please read the manual carefully before use
- Our company reserves the right to interpret the manual
- Please refer to the actual product appearance
- In case of product technology or software upgrades, without prior notice

Content

Product Introduction	3
I Introduction	5
II Transportation Damage	5
III Safety Introduction	5
LPG powered refrigerators safety awareness	9
IV Warning	10
Electrical Grounding Instructions	10
Ventilation Warning	10
Energy Use Warning	10
V Installation and Use Instructions	11
Levelling and Ventilation	11
Gas Connection	14
How to change a new gas bottle	15
Operation control panel	16
12V DC Connection	24
Instructions of thermostat	25
How to adjust temperature	25
Cooling compartment	26
Freezing compartment	26
Defrost	26
VI Regular Care and Maintenance	27
Inside Lighting (Certain models)	27
Care and maintenance for electricity refrigerators	28
Care and maintenance for LPG burner	28
Replace the battery for electronic spark ignition	30
VII Types of faults and common problems	32
Trouble shooting	34
VIII Door removal & reversal instructions (option)	35

Product Introduction

Model: DSG-40B1*
DSG-60B1*



Model: DSG-40B1*-A
DSG-60B1*-A



Model: DSG-70B1*



Model: DSG-100B1*-A
DSG-100D1*-A



Model: DDG-185D1* / DDG-185B1*
DDG-275D1* / DDG-275B1*
DDG-540S1*

Model: DSG-200D1*



I Introduction

Thank you for purchasing our gas refrigerator. This unit is designed to improve your living and entertaining comfort. The absorption system is totally silent that uses no compressors or fans. The refrigerator is ideal for installation in homes, farms, Cottages, chalets or similar. With its silent operation and unique design, you will enjoy the convenience and comfort for years to come.

Please read through these instructions carefully before operating this refrigerator. When using it, always exercise basic safety precautions.

This easy-to-use manual will guide you to getting the best use of this refrigerator: The appliance is suitable for camping use when use gas;

The appliance may be connected to more than one source of energy;

The appliance shall not be exposed to rain;

This appliance is intended to be used in household and similar applications such as:

Suitable for camping use when use gas, Don' t suitable for camping when use electricity, only household and indoor use only when use electricity.

II Transportation Damage

Inspect the refrigerator for damage. Transit damage must be reported to whoever is responsible for delivery not later than seven days after the refrigerator was delivered.

Operating in excess of these specifications can damage the refrigerator's electrical circuit, related components and voids the refrigerator's warranty.

III Safety Introduction

1.Do not allow children to play with the Refrigerator, even when it is turned off;

2.Do not use store liquids such gasoline, kerosene, etc., inside your Refrigerator, thus avoiding the risks of explosions and fire;

3. Do not store toxic materials inside your Refrigerator, as they could contaminate food items;

4. Your Refrigerator should be used only by those who have read this manual or those that have been adequately instructed by someone who has read it.

5. This appliance can be used by children aged from 8 years and above and persons with reduced physical, sensory or mental capabilities or lack of experience and knowledge if they have been given supervision or instruction concerning use of the appliance in a safe way and understand the hazards involved. Cleaning and user maintenance shall not be made by children without supervision.

6. If the supply cord is damaged, it must be replaced by the manufacturer or its service agent or a similarly qualified person in order to avoid a hazard. The appliance shall be disconnected from its power source during service and when replacing parts;

7. These appliances use flammable insulation blowing gas, please dispose the appliance according to the local regulation.

8. Do not store explosive substances such as aerosol cans with flammable propellant in this appliance.

9. The sealed cooling system must not be opened, since it contains corroding chemicals under high pressure.

Precautions before use

Use this appliance only for its intended purpose as described in this user manual. This absorption refrigerator must be properly installed in accordance with the installation instructions before it is used.

1. Please confirm whether the refrigerator is the one you chose and whether the energy source it uses complies with your requirement.

2. For your safety, remove all the packing materials before operating the product.

3. It is very important to put your refrigerator in a relatively cool, dry and well-ventilated place to avoid direct exposure to the sun. Do not put it near flammable materials such as gasoline. The ground should be firm and level. The adjustable bottom screws should directly stand on the ground in order

to ensure its steadiness.

4.Never install a gas appliance on carpeting or against a flammable wall.

5.Never leave your gas appliances running unattended while on vacation.

6.Never unplug your absorption refrigerator by pulling on the power cord. Always grasp the plug firmly and pull straight out from the wall outlet.

7.Unplug your absorption refrigerator before cleaning or before making any repairs.

8.Do not operate your absorption refrigerator in the presence of explosive fumes.

9.The power supply must be properly grounded. Do not use a cord that shows cracks or abrasion damage along its length, the plug or the connector end.

Precautions for Use

1.For your safety, do not store gasoline or any other flammable vapor and liquid in the unit. Do not store erosive materials, for example, strong acid or alkali in the unit. Do not use the above-mentioned materials nearby especially when it is on.

2.This type of refrigerator works on heat-cooling alternation; thus, it is forbidden to touch the pipes at the back in case it might cause irritating burns.

3.If the unit is equipped with a thermostat, the temperature can be regulated by the thermostat. The thermostat does not indicate a concrete temperature but can only adjust the temperature from a high to a low level and vice versa. Users, according to their actual situation (ambient temperature, wanted temperature and quantity of the stored items), can adjust the thermostat valve's position. We suggest that you first enquire of the distributor about the proper use of thermostat.

4.Storing flowers, vaccine and drugs in the refrigerator is not an approved action. If you indeed need to store these items, ask for instructions and notices from the manufacturer

5.Separate cooked and uncooked foods when store them. Leave some space among the foodstuff for air circulation. You'd better not put hot foods in the compartment before they cool down naturally. It is best to pack the

foods with peculiar smells with plastic membrane before storing them. Glass containers as well as canned drinks are not to be placed in the freezing compartment, where a rupture or split might happen due to the strong freezing. When the cooling compartment (without a thermostat) possibly reaches a temperature below 0°C, glass-contained foods, eggs and vegetables should not be put there in order to avoid rupture and split.

6. Dust on heat-dissipating unit at the back should be cleaned periodically. Otherwise, the cooling effect may be affected. It is best to do so every 10 days or so.

7. On its initial use, do not put any items in the refrigerator. Allow the refrigerator to cool for 24 hours before loading any foods. For the first time, the volume of foodstuff should not be more than 1/3 of the total capacity. After another 24 hours, put in other foods successively. Remember to leave 1/5 of the total capacity for good cool-air circulation. During its running, do not open the doors too frequently than needed.

8. When the frost thickness in the freezing compartment exceeds 4mm, you should stop the running to defrost, or the cooling can be impaired.

9. Suppose your refrigerator has been used out and you are about to throw it away; or you want to put it aside for some period, we suggest you uninstall the doors and take out the shelf, so as to prevent children's ingoing and probably subsequent door-closing, thus to avoid any possible injury to them.

10. Only one power source may be used at any given time. It is strictly forbidden to operate two power supply units simultaneously. For example, if your refrigerator is a three-way unit, when it is powered by electricity, the other two power sources must not be used concurrently.

11. The refrigerator has already been tested by the manufacturer and proved to comply with the company standard. If there is any problem, please contact us.

Caution: When system is running on gas, the LPG tank as well as the burner should never be in the slide way, both must be removed from the back of the refrigerator and be placed in another place.

LPG powered refrigerators safety awareness

On its initial use, you should inspect the tightness of all valve connecting pipes. Turn on the gas bottle valve (Note: Do not ignite the flame), check all completed connections for leaks with soapy water.

Only after confirmation for security can you go on with further operation.

1. When you smell gas leak during operation, the steps below must be followed:

a) Shut off the general valve of gas bottle

b) Don't use any electric appliance including telephone

c) Open the windows immediately for air flow

d) Extinguish open flame around

e) Contact the local supplier for troubleshooting. You are forbidden to use the unit before the trouble is solved.

2. When you use LPG to operate the refrigerator, we suggest that you install an exhaust pipe linked to the outside of the room, otherwise, there is a hazard of CO poisoning.

3. Never put the refrigerator in bedroom when it is LPG powered.

4. Do not touch the back of the unit while it is in use.

5. There should not be flammable materials or exploders heaping up in the vicinity of the appliance.

6. You must obey local regulations and laws concerning gas equipment. Be sure your gas type complies with that of your local place. Never allow kids or the unintelligent who have no custodian to operate the gas burner setup. For personal life and property security, do not let a child to run the appliance.

7. The passing LPG pressure of the valve is 28-30mbar.

8. LPG Gas (a mixture of butane, propane and other gases), hereinafter referred to as LPG.

9. An approved manual shut-off valve must be installed at the gas inlet of the refrigerator. When the equipment is in the installation position, the user must be able to access the stop valve.

You must immediately shut off the unit whenever you found a gas leak.

IV Warning

Electrical Grounding Instructions

This appliance is equipped with a plug with grounding for your protection against shock hazards and should be plugged directly into a properly grounded receptacle. Do not cut or remove the grounding prong from this plug.

The cord is approximately 5 feet long and a grounded three-prong receptacle should be installed in an accessible position within reach of the plug. Do not use any extension cord!

Do not use an adapter plug or extension cord.

Do not use the unit in the immediate surroundings of a bath, shower or swimming pool.

Ventilation Warning

Provide ample ventilation, especially when sleeping. This refrigerator consumes air (oxygen). Do not use this refrigerator in unventilated structures to avoid endangering your life. Provide additional ventilation for any additional fuel-burning appliances and additional occupants.

It is highly suggested that you read this manual carefully before starting to operate our Absorption-Diffusion Double-way refrigerators.

Energy Use Warning

Only one type of energy is allowed to be used when it is on. It is strictly forbidden to run two power means together simultaneously. For instance, suppose your refrigerator is a two-way one, when it is powered by electricity, the other source must not be used at the same time.

Caution: When system is running on gas, the gas cylinder as well as the burner should never be in the slide way, both must be removed from the back of the refrigerator and be placed in another place.

Before you start to operate our product, please read the following content and follow the operation instructions listed. When confronting a problem, turn to the local distributor for help, do not handle it by yourself.

V Installation and Use Instructions

It is advisable to clean the inside of the absorption refrigerator with lukewarm water using a mild detergent, and then to dry it thoroughly prior to use. The refrigerator must be placed in a ground that is firm and flat. Make sure it is in the same level position from the aspects of four directions. All the four adjustable bottom screws should directly stand on the ground. It is highly suggested that you ask a qualified technician to help install the refrigerator, or the cooling effect may be impaired.

When you want to use the unit in an automobile, please turn to the distributor and ask them to install for you.

The gas system of our refrigerator is LPG. In case that you need to use coal gas or natural gas; you should first get consent of local gas-supply department and ask for their assistance in installing the gas-supply pipeline.

Meanwhile, contact the distributor and ask them to change the jet for you. It cannot be operated before all its connections have been tested and confirmed to be safe.

For gas or kerosene powered unit, it should be put in a place where it is convenient to repair the gas or kerosene setup at the back of the refrigerator.

The clearance between the gas bottle and refrigerator should be no less than 1 meter.

Levelling and Ventilation

The refrigeration system of the cabinet is designed to operate with the cabinet located on a flat surface. Avoid tilting the cabinet side.

If the placement angle exceeds 3 degrees, the performance will be poor.

If the cabinet must be tilted on an angle for handling or moving purposes, allow it to sit in an upright position 4 hours prior to plugging it in and starting the cooling of the storage compartment.

Locate the unit away from direct sunlight. This will enable you to obtain the best performance and save energy.

Further the room should have a window (which can be opened) or a door to the outside.

It is important that the refrigerator is not subject to radiation of heat from

a stove etc.

For best performance also at high ambient temperatures there must be a free air circulation over the cooling unit at the rear of the refrigerator. Absorption refrigerators rely on convection air cooling, so it is crucial that air circulates freely around the unit. Always keep the refrigerator's vents open—the better the ventilation, the better the refrigerator performs.

The refrigerator is designed for a free-standing installation.

The room where we install the refrigerator must have good ventilation and provide some Windows, as well as ventilation doors or openings for exhaust in accordance with current laws. This is crucial for ensuring correct exhaust and the optimal operation of the equipment.

Never install gas appliances in unventilated (air tight) structures or sleeping rooms. Gas refrigerators consume air (oxygen) when operated on gas power. When used in any inside area, provide a fresh air opening of at least 3 square inches. Please note that an exterior flue is not required with "vent-less" LPG appliances like gas refrigerators, but you may choose to run an insulated 2 inch (min) inside diameter vent pipe through the roof (straight up is best) or the wall (avoid 90 degrees bends with 45's spaced more than two feet apart). It is recommended that a carbon monoxide detector be installed in the same room as the gas refrigerator.

Ventilation must be in accordance with AS5601-2004 - Gas Installations. In general, the appliance should have adequate ventilation for complete combustion of gas, proper flue and to maintain temperature of immediate surroundings within safe limits.

Keep appliance area clear and free from combustible materials, Gasoline and other Liquids with flammable vapors. Do not obstruct the flow of combustion and Ventilation air.

Free Space Installation

To ensure the circulation, the unit should be kept at least 300 mm, away from the rear wall and possible side walls. The clearance above the refrigerator should be at least 400 mm.

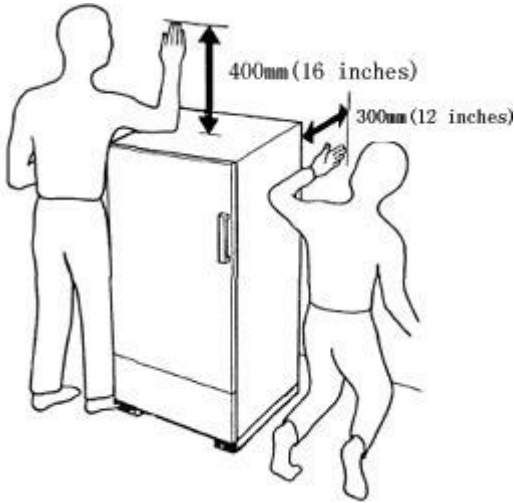

Installation in tight spaces

To ensure correct air circulation, the device should be placed at least 20 cm from the rear wall and at least 10 cm from the side walls.

The clearance above the refrigerator should be at least 20 cm.

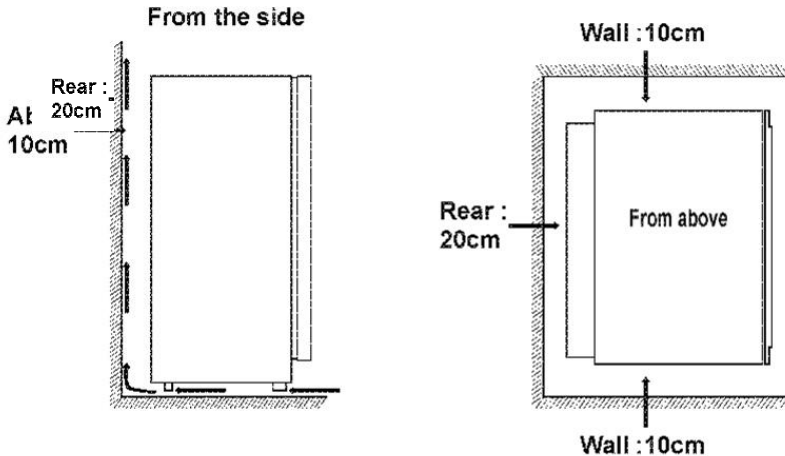

Gas Connection

The refrigerator is designed for operation on LPG, the pressure of which must be 28-30mbar for LPG. Check that this is stated on the data plate. The refrigerator is not designed for operation on town gas or natural gas.

Caution! Check that the gas supplied to the refrigerator is at the LPG pressure. See the pressure regulator on the LPG container

This appliance shall be installed only by authorized persons and in accordance with the manufacturer's installation instructions, local gas fitting regulations, municipal building codes, AS 5601-2004 - Gas Installations and any other statutory regulations.

The gas supply pipe should be connected to the gas inlet of the gas control valve by means of a suitable threaded coupling.

In making the connection to the refrigerator, a union gas cock of an approved bottled-gas type must be incorporated in the supply line in a position which is readily accessible to the user. For eventual servicing purposes, the union should be on the outlet side of the cock and the pipe work should be positioned so as not to prevent the refrigerator from being readily withdrawn.

Never check gas leaks with an open flame. Use an approved leak detection solution.

An approved manual shut-off valve must be installed at the gas inlet of the refrigerator. The shut-off valve must be accessible to the user when the appliance is in the installed position.

Before leaving—Check all connections for gas leaks with soap and water. Do not use a naked flame for detecting leaks. Ignite the burner to ensure correct operation of gas valve, burner and ignition. Turn gas tap to low flame position and observe stability of the flame. When satisfied, please instruct the user on the correct method of operation. In case the appliance fails to operate correctly after all checks have been carried out, refer to the authorized service provider in your area.

Caution: Check that the GAS supplied to the refrigerator is at the proper pressure. See the pressure regulator on the GAS container.

We suggest using 15 kilograms below (with a maximum cylinder

diameter: 320mm) liquefied petroleum gas cylinders, The clearance between the gas bottle and refrigerator should be no less than 1 meter.

This appliance shall be installed only by authorized persons and in accordance with the manufacturer's installation instructions, local gas fitting regulations, municipal building codes.

The gas supply pipe should be connected to the gas inlet of the gas control valve by means of a suitable threaded coupling.

In making the connection to the refrigerator, a union gas cock of an approved bottled-gas type must be incorporated in the supply line in a position which is readily accessible to the user. For eventual servicing purposes, the union should be on the outlet side of the cock and the pipework should be positioned so as not to prevent the refrigerator from being readily withdrawn.

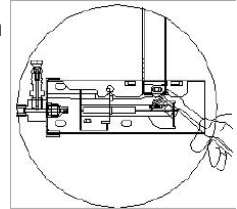

How to change a new gas bottle

Suppose you find the cooling effect of your unit is not as good as before after a certain period, inspect whether there is still gas pressure, if not, shut off the gas cylinder valve, move away the gas cylinder connected to the appliance, change for a new gas bottle, and you can restart your refrigerator now (Refer to section “Installation and Use Instructions”)

Warning: The gas container shall be changed in a position that away from any source of ignition.

Operation control panel

The refrigerator is designed with 3 optional ignition functions.

Please find the same control panel as the one used to purchase the refrigerator for operation.

Model: DSG-40B1* / DSG-60B1*

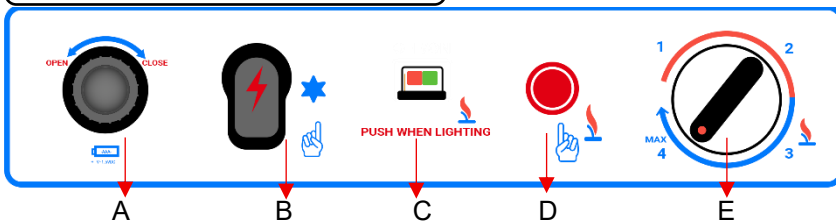

A: Battery cap; B: Pulse switch; C:Flame indicator;
D:Safety valve button; E: Thermostat knob;

1: Using the Refrigerator (Gas Pulse Ignition)

When using the refrigerator with gas as the energy source, the gas connection hose must be securely fastened and sealed. Follow these steps:

- Press and hold the safety valve "D" for 10-15 seconds to purge air from the pipes.
- Continue holding the safety valve button "D", Simultaneously press Pulse switch "B", until the Flame indicator "C" shifts from the red zone to the green zone.
- Continue holding Safety valve button "D" for a further 10–15 seconds until the flame stabilizes before releasing, the refrigerator is now operational.
- You can turn the thermostat knob "E" to get the temperature you want.

1.1: Switching Off the Refrigerator:

When not in use, directly close the safety valve on the gas cylinder, ensuring it is fully shut. Once the flame indicator "C" changes from the green zone to the red zone.

2: AC Operation:

Connect to AC power supply. You can turn the thermostat knob "E" to get the temperature you want.

3: DC 12V Operation:

Connect the DC12V power supply. When using the refrigerator, ensure the power plug is securely inserted into the socket.

4. When using AC/DC power, switch off the refrigerator:

When not in use, simply unplug the AC/DC power cord.

If the refrigerator will remain unused for an extended period, empty all food contents and defrost it. Clean the interior thoroughly and ensure the refrigerator door remains open.

Note: Remember not to use the three usage methods simultaneously. When using AC power, please connect the AC power cord. When using DC power, please connect the DC power cord. When using Gas, please perform orderly operations on the operation panel.

Model: DSG-40B1*-A/ DSG-60B1*-A

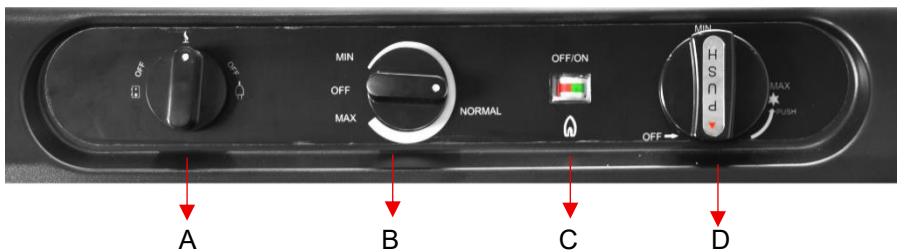

A: Rotary switch B: Thermostat knob C: Flame indicator

D: Safety valve & Pulse switch

1: Using the refrigerator (Gas Pulse ignition)

- Select the gas position at the "A" selector switch.
- Press the safety valve and the Pulse switch "D" and hold it while turning the knob counterclockwise "D" to the MAX position for 10-15 seconds to

purge air from the pipes.

- Check the flame indicator "C" to see if the flame is on. After the flame is ignited, the pointer should move from the red area to the green area.

- Press and hold the safety valve and Pulse switch button "D" for 10-15 seconds.

- Release the safety valve and the Pulse switch button "D" and check again whether the flame is on or not.

- You can turn the thermostat knob "D" to get the temperature you want.

Note: Safety valve has a stuck on each level, depress the safety valve button "D" and hold it down while adjusting the gas flow.

If the Pulse switch fails to spark, you might need to replace the battery.

1.1: Switching off the refrigerator:

When the refrigerator is not in use, close the valve on the gas cylinder directly, ensuring it is securely shut. Once the flame indicator "C" changes from the green zone to the red zone, switch the Rotary switch "A" to the "OFF" position.

2: AC Operation:

Select the AC position on the "A" Rotary switch to activate the power supply. You can turn the thermostat knob "B" to get the temperature you want.

3: DC 12V Operation:

Select the 'DC12V' position at the "A" Rotary switch to activate the power supply. When using the refrigerator with DC12V power supply, ensure the power plug is securely inserted into the socket.

4: When using AC/DC power, switch off the refrigerator:

When not in use, the AC/DC power plug may be unplugged directly.

Select the "OFF" position at the "A" Rotary switch.

If the refrigerator is to remain unused for an extended period, empty all food and defrost it. Clean the interior thoroughly and ensure the door remains open.

Model: DSG-100B1*-A / DSG-100D1*-A

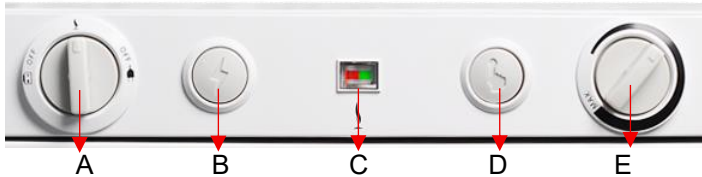

A: Rotary switch B: Pulse switch C: Flame indicator
D: safety valve button E: Thermostat knob

1: Using the Refrigerator (Gas Pulse Ignition)

When using the refrigerator with gas as the energy source, the gas connection hose must be securely fastened and sealed. Follow these steps:

- Select the gas position at the Rotary switch "A".
- Press and hold the safety valve button "D" for 10-15 seconds to purge air from the pipes.
 - Continue holding the safety valve button "D" while simultaneously pressing and holding the Pulse switch "B" until the flame indicator "C" moves from the red zone to the green zone.
 - Then continue holding button "D" for a further 10-15 seconds until the flame stabilizes before releasing. The refrigerator is now ready for use.
- You can turn the thermostat knob "E" to get the temperature you want.

1.1: Switching off the refrigerator:

When the refrigerator is not in use, close the valve on the gas cylinder directly, ensuring it is securely shut. Once the flame indicator 'F'

changes from the green zone to the red zone, the Rotary switch "A" to the "OFF" position.

2: AC Operation:

Select the Rotary switch "A" to the "AC" position. Connect to AC power supply. You can turn the thermostat knob "E" to get the temperature you want.

3: DC 12V Operation:

Select the "DC12V" position at the "A" Rotary switch. Connect the DC12V power supply. When using the refrigerator, ensure the power plug is securely inserted into the socket.

4: When using AC/DC power, switch off the refrigerator:

When not in use, simply unplug the AC/DC power cord. Select the Rotary switch at position "A" to the "OFF" position.

If the refrigerator will remain unused for an extended period, empty all food contents and defrost it. Clean the interior thoroughly and ensure the refrigerator door remains open.

Model: DSG-70B1*

The cable for mains connection, the 12V connecting block and the gas connector are located on the back side of the refrigerator.

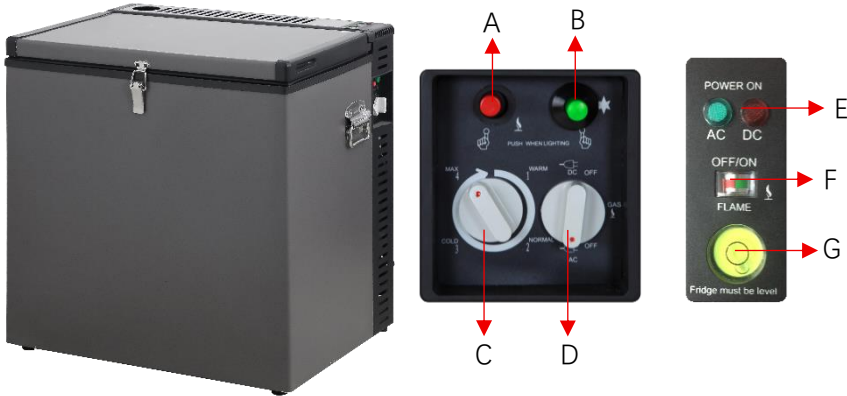

A: safety valve button B: Pulse switch C: Thermostat knob
D: Rotary switch E: Power on lamp F: Flame indicator G: Spirit level

1: Using the Refrigerator (Gas Pulse Ignition)

When using the refrigerator with gas as the energy source, the gas connection hose must be securely fastened and sealed. Follow these steps:

- Select the gas position at the Rotary switch "D".
- Press and hold the safety valve button "A" for 10-15 seconds to purge air from the pipes.
 - Continue holding the safety valve button "A" while simultaneously pressing and holding the pulse switch "B" until the flame indicator "F" moves from the red zone to the green zone.
 - Then continue holding button "A" for a further 10-15 seconds until the flame stabilizes before releasing. The refrigerator is now ready for use.
 - You can turn the thermostat knob "C" to get the temperature you want.

1.1: Switching off the refrigerator:

When the refrigerator is not in use, close the valve on the gas cylinder directly, ensuring it is securely shut. Once the flame indicator "F" changes

from the green zone to the red zone, switch the Rotary switch "D" to the "OFF" position.

2: AC Operation:

Select the Rotary switch "D" to the "AC" position. Connect to AC power supply. You can turn the thermostat knob "C" to get the temperature you want.

3: DC 12V Operation:

Select the "DC12V" position at the "D" Rotary switch. Connect the DC12V power supply. When using the refrigerator, ensure the power plug is securely inserted into the socket.

4: When using AC/DC power, switch off the refrigerator:

When not in use, simply unplug the AC/DC power cord. Select the Rotary switch at position "D" to the 'OFF' position.

If the refrigerator will remain unused for an extended period, empty all food contents and defrost it. Clean the interior thoroughly and ensure the refrigerator door remains open.

**Model: DDG-185D1* / DDG-185B1* / DDG-275D1* / DDG-275B1* /
DSG-200D1* / DSG-200B1* / DDG-540S1***

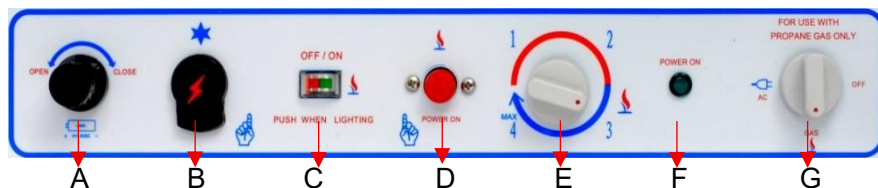

A: Battery cap; B: Pulse switch; C: Flame indicator;
D: Safety valve button; E: Thermostat knob;
F: Power indicator light; G: Rotary switch;

1: Using the Refrigerator (Gas Pulse Ignition)

When using the refrigerator with gas as the energy source, the gas connection hose must be securely fastened and sealed. Follow these steps:

- Select the gas position at the Rotary switch "G".
- Press and hold the safety valve button "D" for 10-15 seconds to purge air from the pipes.
- Continue holding the safety valve button "D" while simultaneously pressing and holding the Pulse switch 'B' until the flame indicator "C" moves from the red zone to the green zone.
- Then continue holding the safety valve button "D" for a further 10-15 seconds until the flame stabilizes before releasing. The refrigerator is now ready for use.
- You can turn the thermostat knob "E" to get the temperature you want.

1.1: Switching Off the Refrigerator

When the refrigerator is not in use, close the valve on the gas cylinder directly, ensuring it is securely shut. Once the flame indicator "C" changes from the green zone to the red zone, switch the Rotary switch "G" to the "OFF" position.

2: AC Operation:

Select the Rotary switch "G" to the "AC" position. Connect to AC power supply. You can turn the thermostat knob "E" to get the temperature you want.

2.1: Switching off the refrigerator:

When not in use, unplug the AC power cord directly. Turn the "G" switch to the "OFF" position.

If the refrigerator will not be used for an extended period, empty all food and defrost it. Clean the interior thoroughly and ensure the refrigerator door remains open.

Note: If the refrigerator will remain unused for an extended period, empty all food and defrost it. Clean the interior and ensure the door remains open.

Please use the ignition method specified for your particular model. Should the burner fail to ignite after 4-5 attempts, proceed as follows:

- Immediately close the gas valve and open the connection between the pressure regulator and the inlet nozzle.
 - Wait at least 5 minutes (to allow residual gas to dissipate).
 - Attempt ignition again.
 - If ignition remains unsuccessful, contact your local authorized service provider.

Note: Should the battery ignition device fail to produce an electric spark, the battery may require replacement.

12V DC Connection

(DSG-40B1* / DSG-60B1* DSG-40B1*-A / DSG-60B1*-A / DSG-100B1*-A / DSG-100D1*-A, DSG-70B1*)

For 3 ways model, there is a terminal block in the rear bottom for 12V DC. You can ignore the positive and negative indication, simply connect the 12V DC power to the two terminals.

It must only be supplied at safety extra low voltage corresponding to the marking on the appliance.

The 12V power cord and its wiring are as follows :



If necessary, please contact the manufacturer.

Instructions of thermostat

(An optional component and its use)

Thermostat is an optional component; its function is to reduce energy needs and keep the temperature in compartment steady. The thermostat is an option for the refrigerator depending on customer's demand. We have electricity thermostat for AC powered refrigerators and gas & electricity thermostat for gas & electricity powered refrigerators.

When powered by DC 12V, the thermostat is not controlled.

How to adjust temperature

Electricity thermostat

Before the finish unit goes out of the factory, its electricity thermostat has been settled in a proper position. Depending on the foods you store, regulate an appropriate position of the knob, which can save energy. Turn the knob according to the marked direction to make the internal temperature either higher or lower.

Gas thermostat

Before the finish unit goes out of the factory, its gas thermostat has been settled in a proper position. The thermostat valve is open so that the burner has abundant gas to run ceaselessly. At this time, the temperature both in cooling and freezing compartments is moderate. Depending on the foods you store, regulate an appropriate position of the knob, which can save energy. Turn the knob according to the marked direction to make the internal temperature either higher or lower.

Cooling compartment

Cooling compartment is used to store fresh foods. Generally, its temperature ranges from 0°C to 10°C.

This compartment is completely closed and not ventilated, for that it must keep a reasonable temperature for storing foods. Therefore, it is best to cover the foods that have peculiar smell or those easily absorb other smells. Store the vegetable and salad with a covered container. The coldest position lies in the vicinity of evaporator and the bottom of the refrigerator; the sub-coldest position lies in the top of the door. Take all these factors into consideration when you are storing different foods.

Freezing compartment

Freezing compartment is used to store frozen foods. Its temperature is below -6°C. The freezing compartment is not designed for prompt freezing; it is just used to store frozen foods. In order to prevent food from air-dry, please reserve the foods with covered boxes, plastic bags and aluminum membrane.

For fast freezing of soft foods and ice cream, you should put them in the coldest position in the freezer, that is, in the vicinity of evaporator cooling fins.

Defrost

Shut off the power of refrigerator (refer to section “How to shut off the refrigerator”) ,take out the foods, open the doors, wipe the water in the compartment after the frost on the evaporator completely melt.

VI Regular Care and Maintenance

Inspect the gas hose periodically for cracks or deep chafing marks. Connections can be tested for leaks using a soap solution.

We suggest that to be checked every month.

Never check gas leaks with an open flame. Use an approved leak-detection solution.

Cleaning the burner

1. Clean the openings and the burner screen with a toothbrush;
2. Clean and inspect the electrode and thermocouple. If either is corroded, have it changed. Check that they are well attached and if necessary, tighten the screws;
3. Check that the spark is created by pressing the electric piezo igniter button on the control panel.
4. Do not use thin objects to either clean or unblock the injector

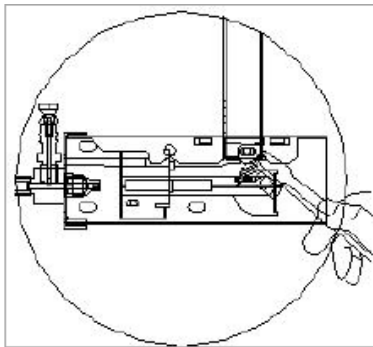

Inside Lighting (Certain models)

Upon opening the door, the light is turned on.

The light operates with 4 batteries, 1.5volts AAA size each.

To change the batteries, use following procedure:

Batteries are mounted on the back of the refrigerator.

You need to replace the batteries periodically in case that the lamp is not bright enough.

To change the light bulb, Remove the plastic cap from the illumination container, replace the light as suggested.

Note: The application scope of this function does not cover all models; only specific models are supported.



Care and maintenance for electricity refrigerators

The energy for cooling system of absorption refrigerator sources from an electric heater, which is an embedded heating system.

If heater needs replacement, first, disconnect the power cord of the refrigerator from power supply. The heater can be changed as follows:

First, make sure that you don't operate this system until it has cooled down.

The heater which is fitted inside the boiler casing (**B**), of the refrigerator unit, can be changed as follows:

1. Pull the power cord out of the wall socket.
2. Remove the cover **C**.
3. Remove some insulation wool so that the heater **A** is accessible.
4. Open the terminal block cover and disconnect the heater leads.
5. Turn and lift the heater out of its pocket.
6. Fit the new heater into the pocket.
7. Connect the leads and close the terminal block cover.
8. Carefully put the insulation wool back into Position and close the cover of the boiler casing.

(Qualified technician only)

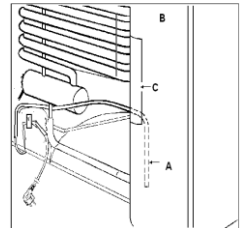

Notice: before operating the unit, you should confirm what energy source it uses. If electricity, make clear about the voltage it demanded. The voltage of our products is AC (the running won't be influenced by the change range from AC).

Care and maintenance for LPG burner

a) When igniting, press the button of gas valve, meanwhile, press the pressing ignitor, you may hear a sound of "ka" the ignitor pin has started to ignite, if the spark can't gather in the center or it is too far from the gas hole of the burner, the gas from the burning hole can't be lit. In that case, you should adjust the position of the ignition pin. Procedure: Loosen the two butterfly-shaped holder screws beside the burner, adjust the ignition pin to a proper position. A clearance of 2-3mm between the pin and the burning hole would be appropriate.

Always keep the ignition pin clean.

b) While the burner is in use, you should clean and adjust it periodically (10 days is advisable). Before cleaning, you must first shut off the gas supply and wait until it cools down. Uninstall the burner, with a soft brush, clean the dust on the burner head. The gas-in hole can also be blown by means of compressed air, or wiped with spirits. However, you are absolutely not allowed to unclog the jet hole or gas line central hole with a needle or needle-like materials, because this will result in either blocking or enlarging the jet hole. Under the former circumstance, the gas may be restricted; under the latter circumstance, the jet hole will be enlarged, resulting in heavy flame and consequently a waste of energy, and so on. We suggest you clean and adjust the burner whenever you change the gas bottle.

c) If the LPG used is of poor quality, there will be accumulated thick dust and soot in the interior of the flue, you should do cleaning work at regular intervals with a brush. You can purchase the brush from the distributor.

d) When the burner is too old (2-3 years) to continually run, turn to the distributor and purchase a new set of burners and ask the distributor or a serviceman from a service center to reinstall it for you.

Note: If the battery ignition fails to spark, you might need to replace the battery. (Qualified technician only)

Cleaning the cooling system flue

Warning: Carbon Monoxide can be hazardous to your health. Gas appliances may emit excessive Carbon Monoxide if the refrigerator's burner, burner orifice, and the flue tube are not regularly cleaned. To prevent Carbon Monoxide, the burner, burner orifice, and the cooling system's flue tube must be cleaned at least once a year and after all prolonged (seasonal) shut-down periods. Refer to the following cleaning procedures, or contact a qualified installer, your dealer.

Before cleaning, put a cloth on the burner to protect it from dirt;

- 1.Remove the refrigerator from its enclosure.
- 2.Remove the heat deflector cap from the flue.
- 3.Remove the spiral flue baffle from the flue tube.
- 4.Using a stiff brush or fine emery cloth, clean the spiral flue baffle of debris.

5. Clean the inside of the flue tube with a flue brush. Inspect burner after cleaning.

6. Re-install the spiral flue baffle. Ensure the spiral flue baffle is securely in place. The spiral flue baffle is required for efficient cooling while operating in the gas mode.

Replace the battery for electronic spark ignition

(DSG-40B1*/DSG-60B1*/DSG-70B1* DDG-185D1* / DDG-185B1* / DDG-275D1* / DDG-275B1*)

When the battery ignition fails to spark, you need to replace the battery, replacement step as follows:

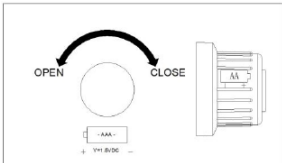

On the far left of the control panel, there is a pulse igniter, grab the lid, turn counter clockwise, remove the battery, and then install the battery clockwise, note: the battery is a No.7 1.5V battery

(DSG-40B1*-A / DSG-60B1*-A)

When the battery ignition fails to spark, you need to replace the battery, replacement step as follows:

1. Find the light box on the top of the limner, remove the fixing screws with a Phillip's screwdriver, and take out the battery box.
2. Replace the old battery with new one. Note: 7#1.5V battery need to be used.



(DSG-100D1*-A / DSG-100B1*-A)

When the battery ignition fails to spark, you need to replace the battery, replacement step as follows:

1. Hold and pull down the "A" as illustrated in pic, take out the battery box.

2. Replace the old battery with new one. Note: 7#1.5V battery need to be used and the red wire must connect to the “+” side of the battery.



VII Types of faults and common problems

Reasons for not cooling and corresponding remedies (Should be done by a qualified service man)

1. AC Operation Failure

- a. Confirm the power supply is available;
- b. Be sure the power wire and the power button are not damaged;
- c. The wire of the heating element must be firm;
- d. If the heating element is damaged and does not heat, change;
- e. Make sure the refrigerator is in a balanced position and is in a water

level;

2. Gas Operation Failure

- a. Once the burner jet clogged, unscrew and wash with alcohol or vapors.

Do not unclog the jet with iron wire or needle-like materials;

- b. Make sure the unit is put in level position;
- c. Confirm the flame is still on;
- d. Check whether the air around ventilates well;
- e. In case there is thick frost on the evaporator and cooling-dissipating plate, shut off the power, open the refrigerator door and defrost it;
- f. If the LPG pressure is not high enough, change the gas bottle in time;
- g. The gas burner should be changed if damaged;

Reasons for odor of gas and relevant solutions:

Whenever you smell odor in the room, you should check immediately:

1. The improper installation of burner may lead to the flame's burning on the heat-wall, relocate it; incorrect installation of the burner may also cause heavy smoke and discolor the warm-keeping cover even the whole unit.

2. The burner should be changed if damaged;

3. If the flue is too short, extend it with a soft thin metal tube linked to the outside of the room.

4. If the interior of the flue is too dirty, clean with the special brush supplied.

5. In case the gas or kerosene being used proves to be of poor-quality, substitute with good quality type.

Reminder:

We are very grateful that you choose Absorption-Diffusion multi-way refrigerator manufactured by our Company.

We assure you of reliable quality for our products, yet we do not hold responsibility for the trouble caused by improper installation or incorrect operation. If there is any more problem, you'd better contact the distributor or a service center for advice.

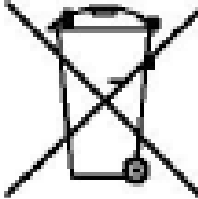
Correct Disposal of this product	
	<p>This marking indicates that this product should not be disposed with other household wastes throughout the EU. To prevent possible harm to the environment or human health from uncontrolled waste disposal, recycle it responsibly to promote the sustainable reuse of material resources. To return your used device, please use the return and collection systems or contact the retailer where the product was purchased. They can take this product for environmentally safe recycling.</p>

Trouble shooting

Problem	Likely Cause	Solution
Refrigerator and/or Freezer are to warm	. Is the burner lit	If the burner is not liter-light and check operation. If the burner does not light, refer to "Burner will not Light".
	. Is it time to defrost	Defrost according to Owner's Manual.
	. Is the gas pressure correct	Have a qualified technician check your gas precunei's. local propane company. The gas pressure should be 11" water column.
	. Is the ambient temperature extra warm	Limit door openings to absolute minimum.
	. Are the condenser fins dirty	Clean the condenser fins.
	. Are the absorber coils dirty	Clean the absorber coils.
	. Do you smell ammonia	If there is an ammonia smell, the cooling unit is leaking and must be replaced.
	. Check for frost on evaporator outlet tubing	Tip refrigerator forward to 10:00 position and hold it there for 5 seconds, or you can wait for 10-12 hours and refrigerator will quit by itself.
. Is the refrigerator level	Level the refrigerator according to the Owner's Manual.	
Refrigerator compartment freezes me food	. Is the burner modulating? (flame goes from "high" to "low" flame while someone else turns thermostat knob from "MAX" to "MINIMUM")	If flame does not modulate, it may be possible that the thermostat is defective. Contact your local Diamond dealer for further information and replacement.
	. Refrigerator is located in an unheated area, or where the temperature is low	If the area where the refrigerator is below 50°F, you must either move the refrigerator to a heated area, or build a cover for the refrigerator.
	. Thermostat knob is at a cold setting	Turn thermostat knob counterclockwise to the warmest position, and then turn it clockwise to setting "2".
Burner will not Light	. Ignitor will not spark	Reconnect ignitor wire. Inspect that the spark electrode tip is not further from burner slots than 1/8"
	. Ignitor wire may be shorting out	Inspect the ignitor wire for frays and tears, and if torn or frayed, call your local Diamond dealer to get a replacement.
	. Is the piezo ignitor functioning	Operate the ignition more often when lighting. Push the button rapidly until the flame lights.
Ignitor sparks, but burner will not light or stay lit.	. Thermocouple may be bad	If flame does not stay lit when you release the gas safety valve, replace the thermocouple.
	. Is the gas pressure correct	Have a qualified technician check your gas pressure. i.e. local propane company. The gas pressure should be 11" water column.

Note:

Frost on evaporator tube will only occur when refrigerator has not been running for a period of time, or upon initial start-up. (first time refrigerator is lit)

VIII Door removal & reversal instructions

(option)

How to reverse the door (See picture 1)

DSG-40B1* / DSG-60B1*

1. First, place the refrigerator upside down and remove the fixing screws on the lower hinge at position 2 in the picture with a Phillips screwdriver

2. Then remove the door and place it on a soft object to prevent damage to the door

3. Then take the hinge shaft at position 1 in the figure below and install it at the same position on the other side.

4. Then attach the door body to the refrigerator and secure the lower hinge.

5. Stand the refrigerator up, then remove the handle and install it on the other side.

6. Finally check whether the door seal is flashing, if it is flashing, blow the hot seal with the hair dryer to close.

How to reverse the door (See picture 2)

1. Remove the lower hinge by loosening and removing the screws with screwdriver (2).

2. Carefully lower the door and remove it.

3. Remove the two screws from the left top hinge (1) position, take the plastic part off the hinge position.

4. Remove the two screws from the right top hinge and take off the hinge, insert the

5. plastic part, rivet the two screws thereafter.

6. Take off the lower hinge and fix it to the opposite side.

7. Take the door. Insert the lower hinge axle into the right bottom hole of the door.

8. Fix the spare hinge to the left top position of the cabinet. Adjust the door, make it straight and in alignment with the cabinet.



Note: As the door gasket gets pressed-in during shipment, after reversing the door the gasket might have to be reset. This will be good for seal to avoid any air escaping. If there is a gap between the cabinet and the door gasket, set the gasket by gently pulling it out to seal the gap. If necessary, you are recommended also to use the hair drier to warm the gasket to get rid of the gap.

Model: DDG-185D1* / DDG-185B1* / DDG-275D1* / DDG-275B1* / DSG-200D1* / DSG-200B1* DDG-540S1*

Note: The direction in which your refrigerator doors open (door swing) can be reversed, from left to right or right to left, by moving the door hinges from one side to the other. Reversing the door swing should be performed by a qualified person.

1. Remove top hinge cover.
2. Remove top hinge with Phillip screwdriver and lift freezer door off of center hinge and set door aside.
3. Unscrew center hinge with Phillip screwdriver.
4. Lift refrigerator door off of bottom hinge and set aside.
5. Remove bottom hinge with Phillip screwdriver.
6. Now remove all plugs and caps from opposite side and place them in the holes you just remove the screws from.
7. Using a Phillips screwdriver fasten the bottom hinge in place using the screws you previously removed.
8. Place fridge door on bottom hinge, then place middle hinge in top hole of fridge door and using the Phillips screwdriver, fasten the middle hinge in place using the screws you previously removed.
9. Now place the freezer door on top of the middle hinge, then place top

hinge in top hole of the freezer door and using the Phillips screwdriver, fasten the top hinge in place using the screws you previously removed.

10. Tighten all screws while making adjustments where necessary to ensure they are aligned correctly and closing well against the cabinet, this will reduce any excessive frost build up.